

SG 6870

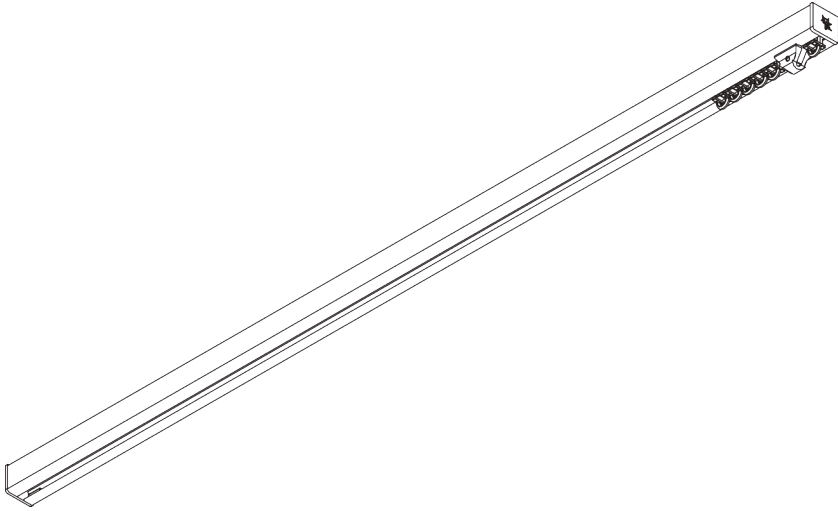

PRODUCT INFORMATION

- **Operation:** hand
- **Range:** M - L
- **Fitting:** ceiling, wall, recess
- **Colours:** white RAL 9016, black RAL 9005 or anodised aluminum, special colours possible (recess profile only in white RAL 9016, black RAL 9005 or special color)
- **Fabrics:** refer to Silent Gliss fabric collection

Features:

- 2-component (2C) glider technology
- Wave (2C)
- Bendable
- Bendable recess profile

SYSTEM SPECIFICATIONS

A. PROFILE

Profile and bending information

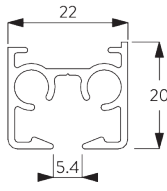

SG 11190

Profile

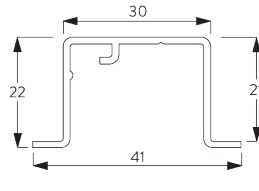

SG 11230

Recess profile



B. HOW TO MEASURE

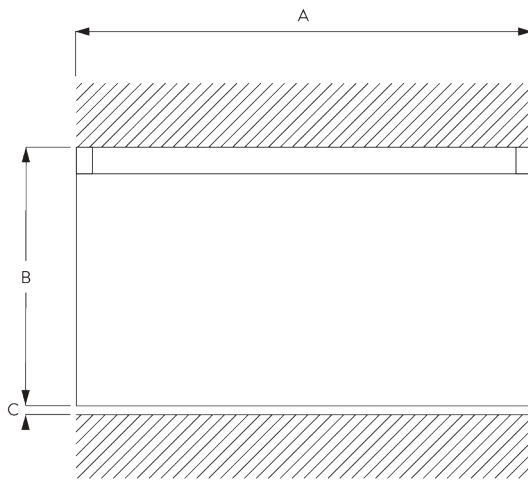

A: System width

B: System height

C: Distance between floor and fabric

C. SPECIFICATION TEXT

Silent Gliss SG 6870 Hand Operated Curtain Track System. Comprises aluminium profile SG 11190 supplied made to measure, available in silver anodised or powder coated in white / matt white / anodic grey / antique bronze / charcoal / black. Supplied as standard with 2C gliders SG 11300 at 14/m, 2 end covers SG 11233 and 2 end stops SG 6065. Top fixed with fixing clamp SG 3825 at 500mm centres. Optional top fix bracket SG 3832 / Wall fix with SG Smart Fix brackets SG 11201-11205 and SG 3826 or SG 3832 / Square Smart Fix brackets SG 11210-11215 and SG 3826 or SG 3832 / SG Universal Smart Fix brackets SG 11154-11156

FITTING

A. FITTING INFORMATION

Fixing points

For detailed fitting information, visit the Silent Gliss website.

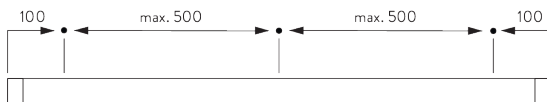

B. CEILING FITTING

Clamp SG 3825

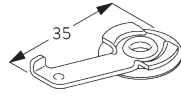
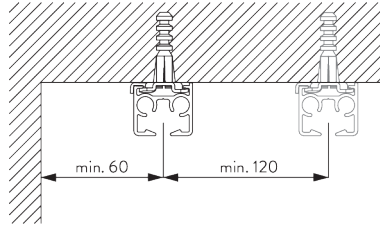

SG 3825

Clamp

Bracket SG 3826

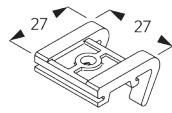
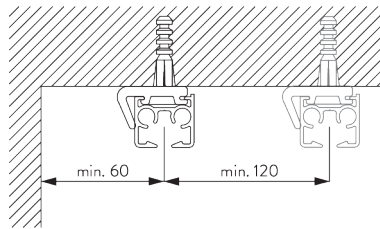

SG 3826

Bracket

Bracket SG 3832

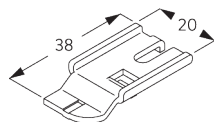
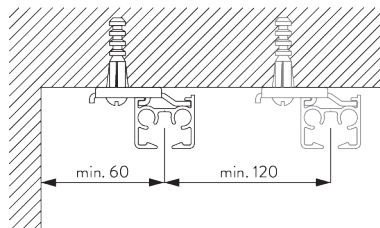

SG 3832

Bracket

C. WALL FITTING

Smart Fix

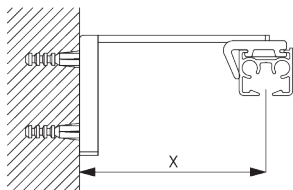

Smart Fix SG 11200 - SG 11205 and bracket SG 3826:
Screw SG 10492 (M4x8) needed.

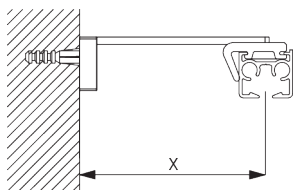

Square Smart Fix SG 11210 - SG 11215 and bracket SG 3826:
Screw SG 10492 (M4x8) needed.

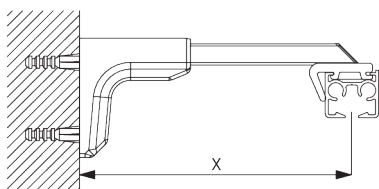

Universal Smart Fix SG 11154 - SG 11156 and bracket SG 3826:
Screw SG 10277 (M4x12) needed.

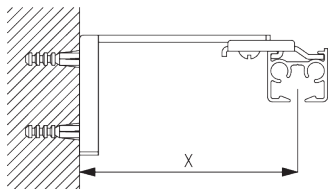

Smart Fix SG 11200 - SG 11205 and bracket SG 3832:
Screw SG 10492 (M4x8) needed.

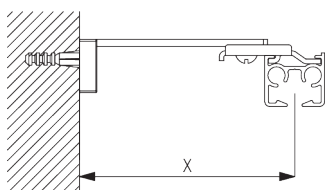

Square Smart Fix SG 11210 - SG 11215 and bracket SG 3832:
Screw SG 10492 (M4x8) needed.

Smart Fix	X mm (SG 3826 / SG 3825)	X mm (SG 3832)
SG 11200 / SG 11210	52	70
SG 11201 / SG 11211	72	90
SG 11202 / SG 11212	92	110
SG 11203 / SG 11213	112	130
SG 11204 / SG 11214	142	160
SG 11205 / SG 11215	192	210
SG 11154	102-130	120-148
SG 11155	132-160	150-178
SG 11156	182-210	200-228

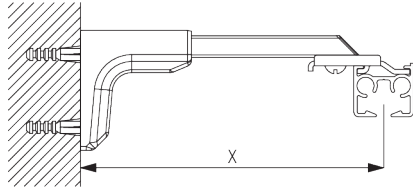

Universal Smart Fix SG 11154 - SG 11156 and bracket SG 3832:

Screw SG 10407 (M4x10) needed.

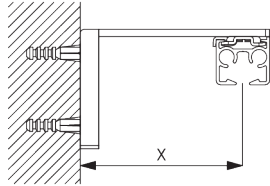

Smart Fix SG 11200 - SG 11205 and clamp SG 3825:

Screw SG 10074 (M4x8) needed.

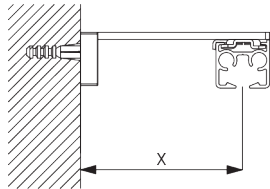

Square Smart Fix SG 11210 - SG 11215 and clamp SG 3825:

Screw SG 10074 (M4x8) needed.

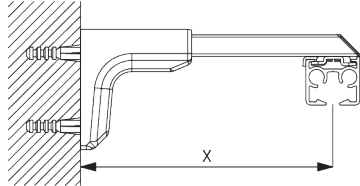

Universal Smart Fix SG 11154 - SG 11156 and clamp SG 3825:

Screw SG 11158 (M4x12) needed.

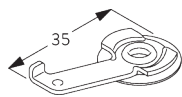

SG 3825
Clamp

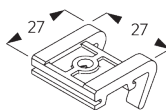

SG 3826
Bracket

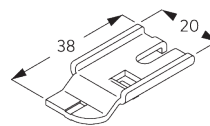

SG 3832
Bracket



SG 10074
Countersunk head screw
M4x8



SG 10277
Pan head screw M4x12



SG 10407
Pan head screw M4x10



SG 10492
Pan head screw M4x8



SG 11158
Countersunk head screw
M4x12

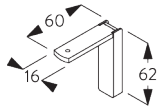

SG 11200
Smart Fix 60 mm

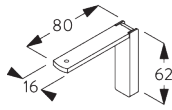

SG 11201
Smart Fix 80 mm

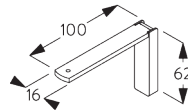

SG 11202
Smart Fix 100 mm

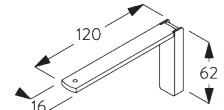

SG 11203
Smart Fix 120 mm

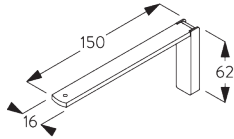

SG 11204
Smart Fix 150 mm

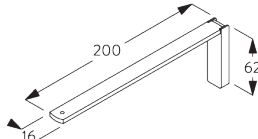

SG 11205
Smart Fix 200 mm

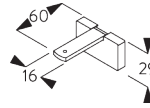

SG 11210
Square Smart Fix 60 mm

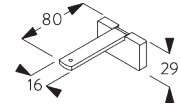

SG 11211
Square Smart Fix 80 mm

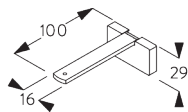

SG 11212
Square Smart Fix 100 mm

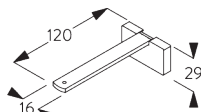

SG 11213
Square Smart Fix 120 mm

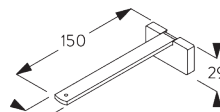

SG 11214
Square Smart Fix 150 mm

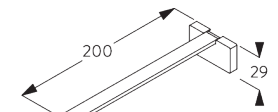

SG 11215
Square Smart Fix 200 mm

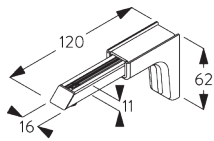

SG 11154
Universal Smart Fix 120 mm

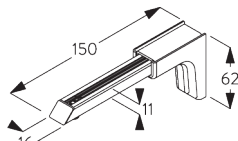

SG 11155
Universal Smart Fix 150 mm

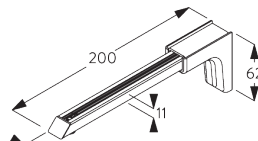

SG 11156
Universal Smart Fix 200 mm

Bracket SG 3836

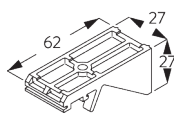
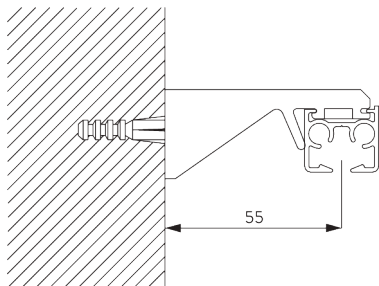

SG 3836
Bracket

D. RECESS FITTING

Recess profile SG 11230

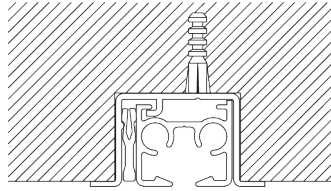

One wedge SG 10157 per fixing point.
For detailed recess fitting, visit the Silent Gliss website.

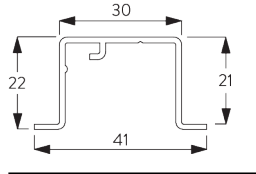

SG 11230
Recess profile

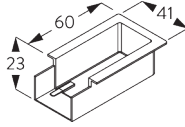

SG 11238
Recess Mask

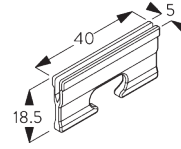

SG 10157
Wedge

SYSTEM OPTIONS

A. WAVE

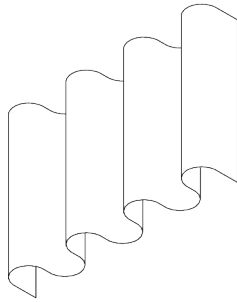

SG 11295

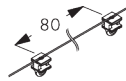

SG 11302

Standard components:

- SG 11295 End stop
- SG 11302 Wave 2C glider cord 80 mm



SG 2255



SG 2256

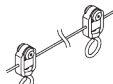

SG 6099

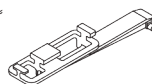

SG 6364

Optional components:

- SG 2255 Brake
- SG 2256 Brake
- SG 6099 Wave roller cord 80 mm
- SG 6364 Wave extension
- SG 6365 Wave hanger
- SG 6366 Wave carrier for draw rod
- SG 10430-34 Draw rod
- SG 11303 Wave 2C glider cord 60 mm



SG 6365

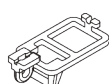

SG 6366

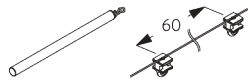

SG 10430-34

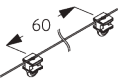

SG 11303

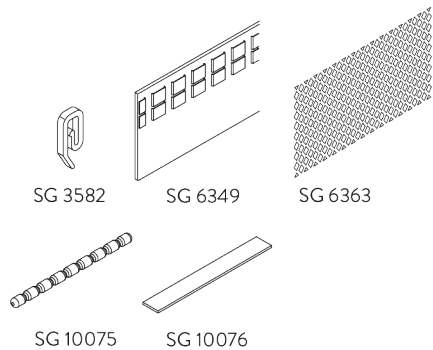

Curtain components:

- SG 3582 Hook
- SG 6349 Wave curtain tape
- SG 6363 Wave top hemming tape
- SG 10075 Lead weight 50 gr/m
- SG 10076 Fabric weight

Wave stack depth - 2C glider cord (standard components)

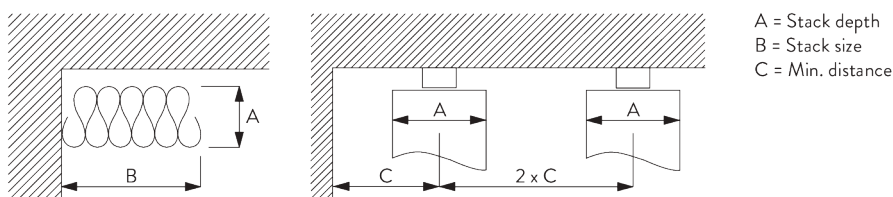

A = Stack depth
 B = Stack size
 C = Min. distance





2C Glider cord SG 11302	Pockets between hooks	Approx. curtain fullness	Stack depth A	Stack size B*	Min distance C
80	6	~2.1	140	180 per metre of track	90
80	7	~2.3	160	180 per metre of track	100

2C Glider cord SG 11303	Pockets between hooks	Approx. curtain fullness	Stack depth A	Stack size B*	Min distance C
60	4	~2.1	100	230 per metre of track	70
60	5	~2.3	120	230 per metre of track	80





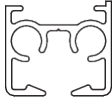
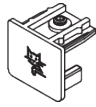





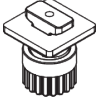

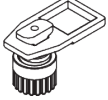

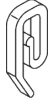
*Stack size B when using optional extension arm SG 6364
 increases by 95 mm per curtain stack!

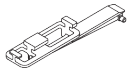
PARTS

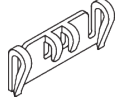
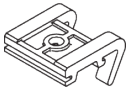
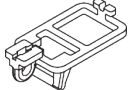
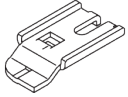
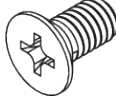
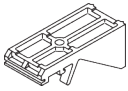
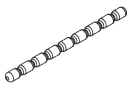
A. STANDARD PARTS

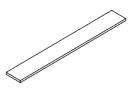
	SG 3825 Clamp
	SG 6065 End stop
	SG 11190 Profile
	SG 11233 End cover
	SG 11300 2C glider

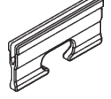
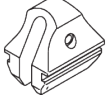
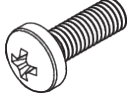
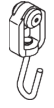
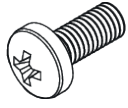
B. OPTIONAL PARTS

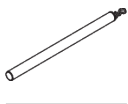
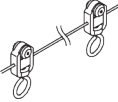
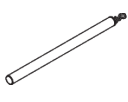
	SG 2255 Brake		SG 6283 Roller
	SG 2256 Brake		SG 6349 Wave curtain tape
	SG 3582 Hook		SG 6363 Wave top hemming tape
	SG 3599 Hook		SG 6364 Wave extension
	SG 3802 Connection bridge		SG 6365 Wave hanger
	SG 3826 Bracket		SG 6366 Wave carrier for draw rod
	SG 3832 Bracket		SG 10074 Countersunk head screw M4x8
	SG 3836 Bracket		SG 10075 Lead weight 50 g/m
	SG 6053 Spring stop		SG 10076 Fabric weight
	SG 6064 End stop		SG 10157 Wedge
	SG 6086 Spring stop		SG 10277 Pan head screw M4x12
	SG 6094 Roller		SG 10407 Pan head screw M4x10
	SG 6098 Roller		SG 10430 Draw rod 50 cm
	SG 6099 Wave roller cord 80 mm		SG 10431 Draw rod 75 cm

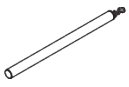

SG 10432

Draw rod 100 cm

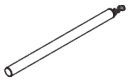

SG 10433

Draw rod 125 cm

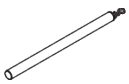

SG 10434

Draw rod 150 cm

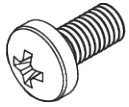

SG 10492

Pan head screw M4x8

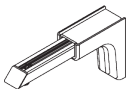

SG 11154

Universal Smart Fix 120 mm

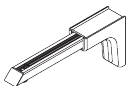

SG 11155

Universal Smart Fix 150 mm

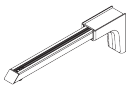

SG 11156

Universal Smart Fix 200 mm

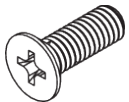

SG 11158

Countersunk head screw M4x12

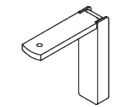

SG 11200

Smart Fix 60 mm

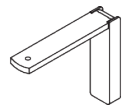

SG 11201

Smart Fix 80 mm

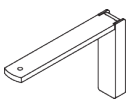

SG 11202

Smart Fix 100 mm

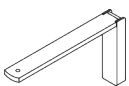

SG 11203

Smart Fix 120 mm

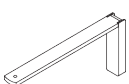

SG 11204

Smart Fix 150 mm



SG 11205

Smart Fix 200 mm

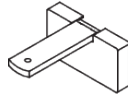

SG 11210

Square Smart Fix 60 mm

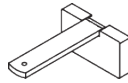

SG 11211

Square Smart Fix 80 mm

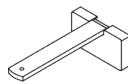

SG 11212

Square Smart Fix 100 mm

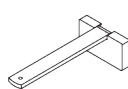

SG 11213

Square Smart Fix 120 mm

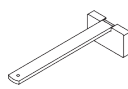

SG 11214

Square Smart Fix 150 mm

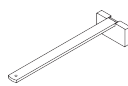

SG 11215

Square Smart Fix 200 mm

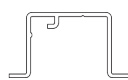

SG 11230

Recess profile

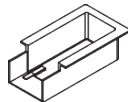

SG 11238

Recess Mask

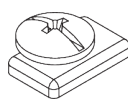

SG 11295

End stop



SG 11301

2C glider on strip

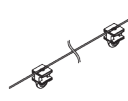

SG 11302

Wave 2C glider cord 80 mm

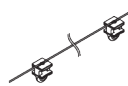

SG 11303

Wave 2C glider cord 60 mm

