

SG 7605

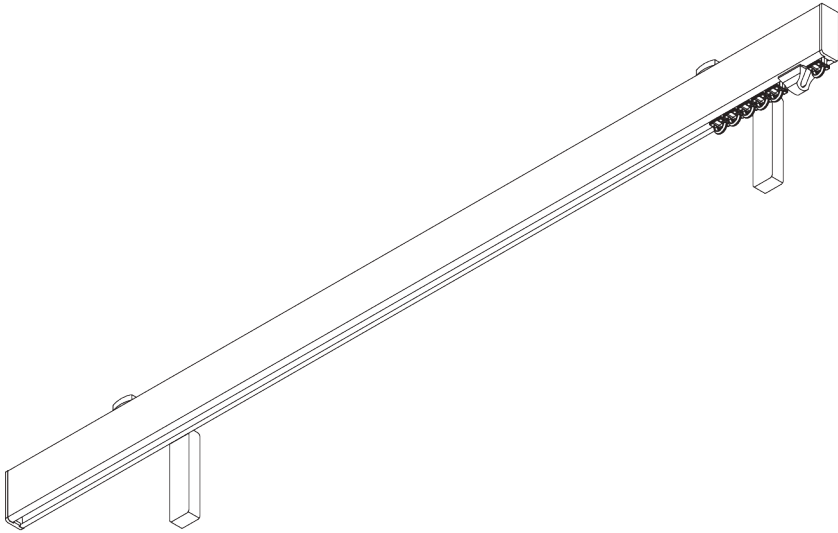
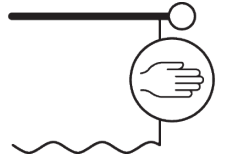

PRODUCT INFORMATION

- **Operation:** hand
- **Range:** S - M
- **Fitting:** ceiling, wall
- **Colours:** white RAL 9016, various colours / finishes
- **Fabrics:** refer to Silent Gliss fabric collection

Features:

- 2-component (2C) glider technology
- Wave (2C)
- Matching endcaps and brackets / bracket covers
- Bendable

SYSTEM SPECIFICATIONS

A. PROFILE

Profile and bending information

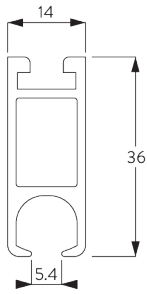

SG 6101

Profile

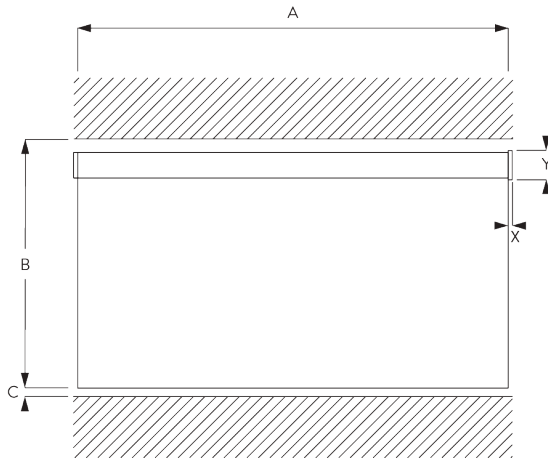

Radius:
20 cm, >25 cm

B. HOW TO MEASURE



A: System width without endcaps
B: System height
C: Distance between floor and fabric
X: Endcap width
Y: Endcap height

Endcap Measurements

		36 mm	
		X	Y
	SG 11601	2	36
	SG 11611	5	40

C. SPECIFICATION TEXT

Silent Gliss SG 7605 'Metropole' hand operated curtain track system. Comprises 36mm h x 14 mm d aluminium profile SG 6100 supplied made to measure with 2C gliders SG 11300 at 14/m, 2 end flush covers SG 11601 and 2 no. end stops SG 6065. Straight poles supplied as standard with wall 'face' fix Smart Fix brackets SG 11206 at max. 600 mm centres. Optional wall fix brackets SG 11207-11208 / SG 11216-11218 / SG 11209 / SG 11472 / Fillet bracket SG 11669. Bent systems for wall 'face' fix supplied as standard with adjustable Smart Fix bracket SG 11209. Ceiling 'top' fix with plate SG 6151 / bracket SG 6175 / SG 11668 at max. 600 mm centres. Finished in Antique Bronze, Gunmetal, Black, Charcoal, Anodic Grey, Slate Grey, Matt White, White, Chrome Effect or Silver Anodised. Matching Flush and Stud endcaps available. Silent Gliss Wave option is available using 60mm glider cord SG 11303/80 mm glider cord SG 11302 / 80 mm roller glider cord SG 6099.

FITTING

A. FITTING INFORMATION

For detailed fitting information, visit the Silent Gliss website.

Fixing points

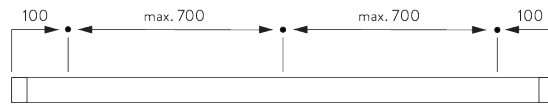

B. CEILING FITTING

Support SG 6151

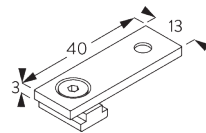
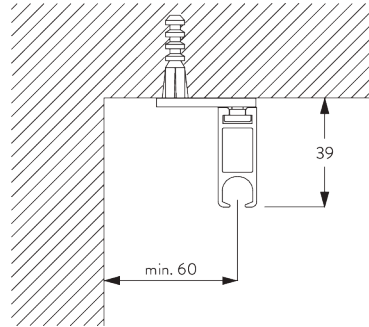

SG 6151

Ceiling support set 3 mm

Top fix bracket SG 11668

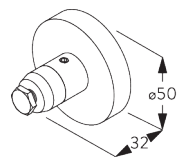
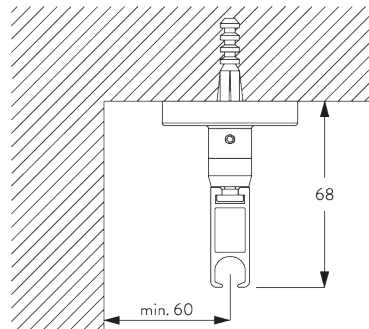

SG 11668

Top fix bracket

Mini hanger SG 6175

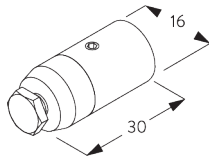
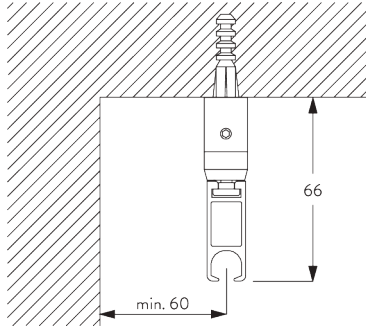

SG 6175

Mini hanger

C. WALL FITTING

Smart Fix

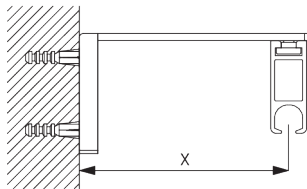

Smart Fix with slot SG 11206 - SG 11208 and SG 6141:
Screw SG 6783 (M4x10) needed.

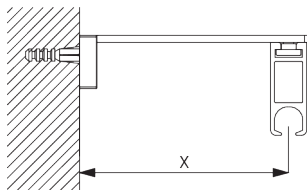

Square Smart Fix with slot SG 11216 - SG 11218 and SG 6141:
Screw SG 6783 (M4x10) needed.

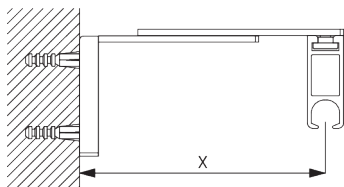

Adjustable Smart Fix SG 11209 and SG 6141:
Screw SG 6784 (M4x8) needed.

Note: all bent Metropole systems are supplied with adjustable bracket SG 11209 as standard.

Smart Fix	X mm
SG 11206 / SG 11216	51
SG 11207 / SG 11217	71
SG 11208 / SG 11218	91
SG 11209 / SG 11472	80-100

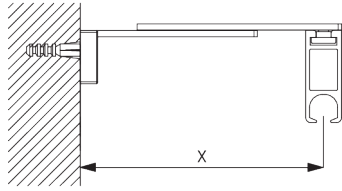

Adjustable Square Smart Fix SG 11472 and SG 6141:

Screw SG 6784 (M4x8) needed.

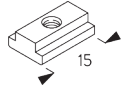

SG 6141

Clamping piece



SG 6783

Hexagon socket countersunk screw M4x10 mm



SG 6784

Hexagon socket countersunk screw M4x8 mm

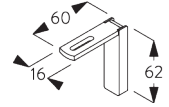

SG 11206

Smart Fix with slot 60 mm

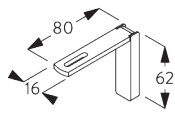

SG 11207

Smart Fix with slot 80 mm

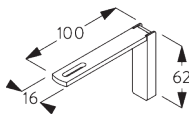

SG 11208

Smart Fix with slot 100 mm

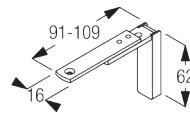

SG 11209

Adjustable Smart Fix

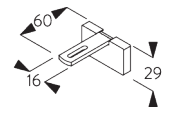

SG 11216

Square Smart Fix with slot 60 mm

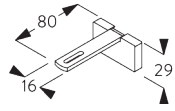

SG 11217

Square Smart Fix with slot 80 mm

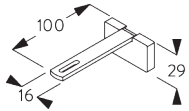

SG 11218

Square Smart Fix with slot 100 mm

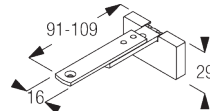

SG 11472

Adjustable Square Smart Fix

Fillet Bracket SG 11669

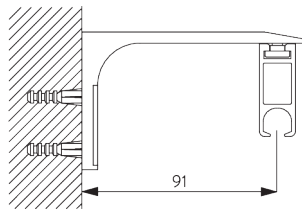

Screw SG 6784 (M4x8) needed.

Recommended for straight systems only.

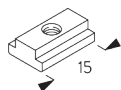

SG 6141

Clamping piece



SG 6784

Hexagon socket countersunk screw M4x8 mm

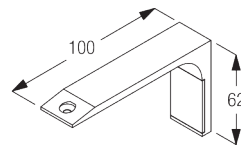

SG 11669

Fillet bracket

**Maxi adjustable
bracket SG 20334**

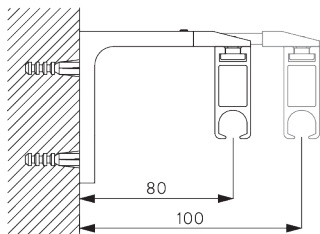

Screw SG 6783 (M4x10) needed.

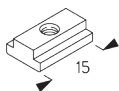

SG 6141
Clamping piece



SG 6783
Hexagon socket countersunk
screw M4x10 mm

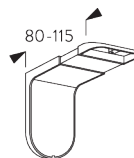

SG 20334
Maxi adjustable bracket

DESIGN & SYSTEM OPTIONS

A. ENDCAPS



SG 11601



SG 11611

Please note:

- Poles are supplied as standard with flush fitting endcaps SG 11601 (left).
- Alternatively, stud endcaps SG 11611 (right) can be selected at no additional cost.

B. WAVE

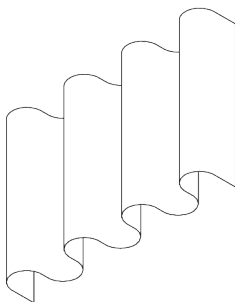

SG 11295

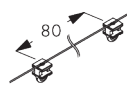

SG 11302

Standard components:

- SG 11295 End stop
- SG 11302 Wave 2C glider cord 80 mm

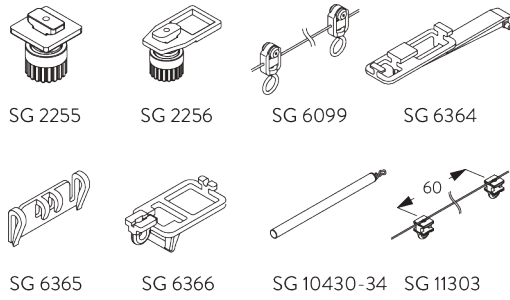

Optional components (min. Radius >25 cm):

- SG 2255 Brake
- SG 2256 Brake
- SG 6099 Wave roller cord 80 mm
- SG 6364 Wave extension
- SG 6365 Wave hanger
- SG 6366 Wave carrier for draw rod
- SG 10430-34 Draw rod
- SG 11303 Wave 2C glider cord 60 mm

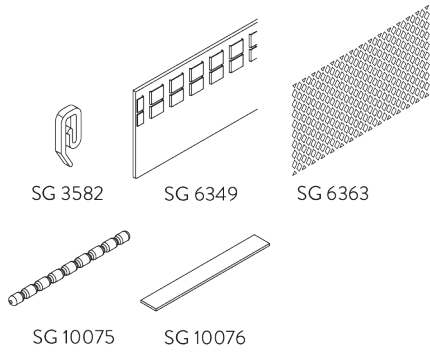

Curtain components:

- SG 3582 Hook
- SG 6349 Wave curtain tape
- SG 6363 Wave top hemming tape
- SG 10075 Lead weight 50 gr/m
- SG 10076 Fabric weigh

Wave stack depth - 2C glider cord (standard components)

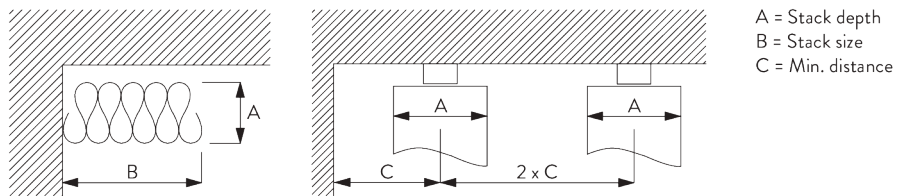

A = Stack depth
 B = Stack size
 C = Min. distance

2C Glider cord SG 11302	Pockets between hooks	Approx. curtain fullness	Stack depth A	Stack size B*	Min distance C
80	6	~2.1	140	180 per metre of track	90
80	7	~2.3	160	180 per metre of track	100

2C Glider cord SG 11303	Pockets between hooks	Approx. curtain fullness	Stack depth A	Stack size B*	Min distance C
60	4	~2.1	100	230 per metre of track	70
60	5	~2.3	120	230 per metre of track	80

*Stack size B when using optional extension arm SG 6364 increases by 95 mm per curtain stack!

PARTS

A. STANDARD PARTS

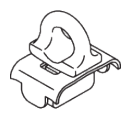

SG 6065
End stop

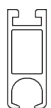

SG 6101
Profile



SG 6141
Clamping piece

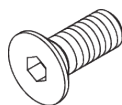

SG 6783
Hexagon socket countersunk screw
M4x10 mm

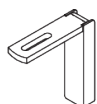

SG 11206
Smart Fix with slot 60 mm

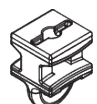

SG 11300
2C glider

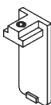

SG 11601
Flush end cap 36 mm

B. OPTIONAL PARTS

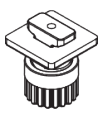

SG 2255
Brake

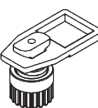

SG 2256
Brake



SG 3582
Hook

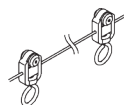

SG 6099
Wave roller cord 80 mm

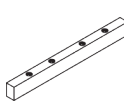

SG 6112
Connection bridge

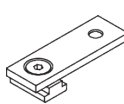

SG 6151
Ceiling support set 3 mm

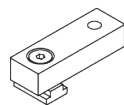

SG 6152
Ceiling support set 9 mm

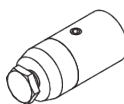

SG 6175
Mini hanger



SG 6283
Roller



SG 6349
Wave curtain tape



SG 6363
Wave top hemming tape

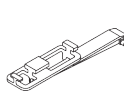

SG 6364
Wave extension

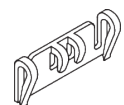

SG 6365
Wave hanger

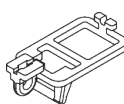

SG 6366
Wave carrier for draw rod

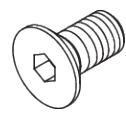

SG 6784
Hexagon socket countersunk screw
M4x8 mm

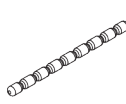

SG 10075
Lead weight 50 g/m

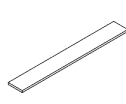

SG 10076
Fabric weight

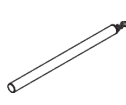

SG 10430
Draw rod 50 cm

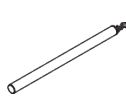

SG 10431
Draw rod 75 cm

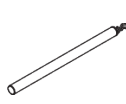

SG 10432
Draw rod 100 cm

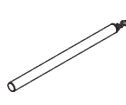

SG 10433
Draw rod 125 cm

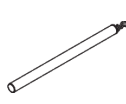

SG 10434
Draw rod 150 cm

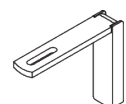

SG 11207
Smart Fix with slot 80 mm

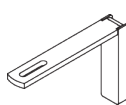

SG 11208
Smart Fix with slot 100 mm

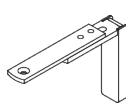

SG 11209
Adjustable Smart Fix

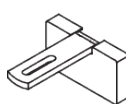

SG 11216
Square Smart Fix with slot 60 mm

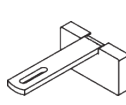

SG 11217
Square Smart Fix with slot 80 mm

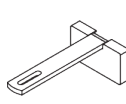

SG 11218
Square Smart Fix with slot 100 mm

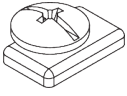

SG 11295

End stop



SG 11301

2C glider on strip



SG 11302

Wave 2C glider cord 80 mm

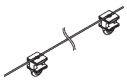

SG 11303

Wave 2C glider cord 60 mm

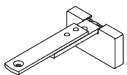

SG 11472

Adjustable Square Smart Fix

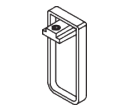

SG 11611

Stud endcap 36 mm

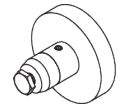

SG 11668

Top fix bracket

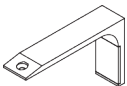

SG 11669

Fillet bracket



SG 20334

Maxi adjustable bracket
